

ERMES WEEK

WIFI digital chronothermostat

Art.DC901-W Cod.5010-W (white)

Art.DC901-B Cod.5011-B (black)



Main Display

1. WI-FI Indicator: The WI-FI indicator does not flash when connected to the WI-FI network
2. History: Operating Time, Temperature Diagram, Humidity Diagram
3. Optional Operation Adjustment
4. Day and clock indicator
5. Home: Maintain a lower temperature to provide frost protection. It also allows for a user-preset lowering temperature while away from home.
6. Hold Temperature, setting the desired time within which you override the thermostat setting.
7. **Air humidification**
 1. If the humidity is below 30% the indicator will be in the red zone
 2. If the humidity is between 30% and 60%, the indicator will be in the green zone
 3. If the humidity is above 60% the indicator will be in the gray area
4. Power ON/OFF
5. Holiday: Illuminates when the thermostat is running in summer
6. Programs
7. Settings
8. Temperature adjustment or menu navigation
9. Temperature adjustment or menu navigation
10. Setting temperature display
11. Display of the detected temperature
12. Display °C or °F
13. Heating flame , indicates the heating activation status

Introduction

Advantages of programmable thermostats

A programmable thermostat helps you save money easily by offering four pre-programmed settings to adjust the temperature of your home and your APPs both in summer and winter, when you are at home, sleeping or outside.

The pre-programmed settings that come with programmable thermostats are intended to offer savings without sacrificing comfort. Depending on your schedule, you can make significant savings by sticking to those settings or changing them appropriately for your family. The key is to establish a schedule that automatically reduces the heating and cooling of your home according to your needs.

Selecting the Thermostat or Timer Mode

There are two modes available where the user can select thermostat mode and timer mode.

Thermostat Mode (Fully Programmable Mode): Allows you to make time and temperature settings. This allows you to program the thermostat to a specific temperature during a specific period.

Clock Mode: Allows you to turn the time-only setting on or off as desired. This mode ignores any temperature.

To switch between thermostat and clock mode:

Follow these steps (use your finger as the screen is touch-sensitive).

01 Press the icon to enter the setup menu

02 Use the page-turning icon (2) Find "feature settings"

03 Use the icon to turn the page (3) find "Select working mode"

04 Select "heating mode" or "timer mode". The thermostat will reset and enter the desired mode

WIFI CONNECTION



the router needs to be 2.4G band only

Pairing the thermostat with the APP

The router must only have the 2.4G band

Download the free app from the Apple Store or Google Play Store by searching for "Smart Life" as below.

Informazioni su questi risultati ⓘ



Smart Life - Smart Living

📄 Installato

Apri

Enable the "Bluetooth" APP for "Smart Life" in your mobile phone settings

Thermostat operation

Then press "Network Settings", find "Wi-Fi Reconfiguration" and press it

APP Operation

Step 1 Register your account

Click "register" after installing the APP

Please read the Privacy Policy and press Agree to proceed to the next step.

The registration account name uses the available email or mobile number and select Region, then click "Continue"

You will receive a 6-digit verification code from your email or SMS

Set the account password. The password must contain 6-20 letters and numbers. Click "Finish"

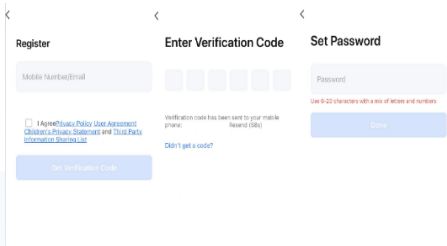

Step 2 Create the house information from "Me"

1. Enter the name of the house.

2. Select or add a room

3. Set location

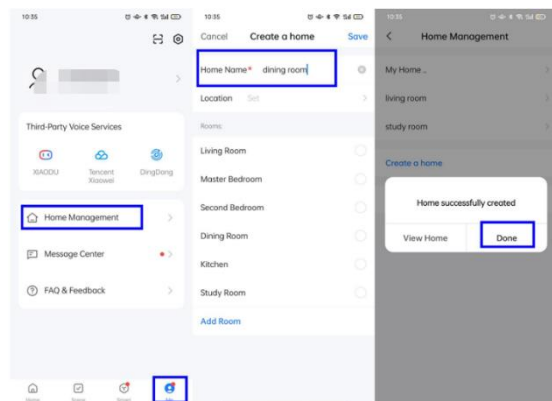

Step 3: Connection

1. Press "Add Device" or "+" in the upper right corner of the APP

2. Add the device in the small appliances section

3. Select the device type "Wi-Fi Thermostat"

4. Enter your router's password.

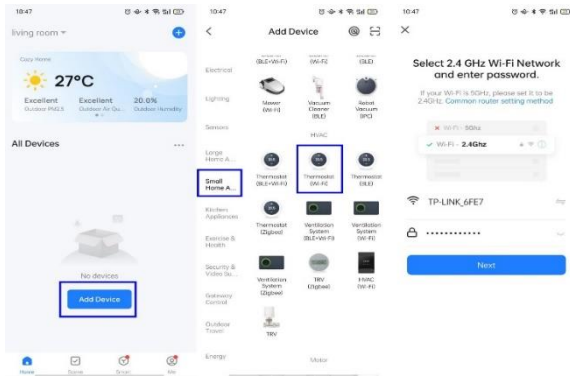

5. By clicking on "Confirm that the indicator is flashing", there are two options. Choose "Blink Quickly" first.

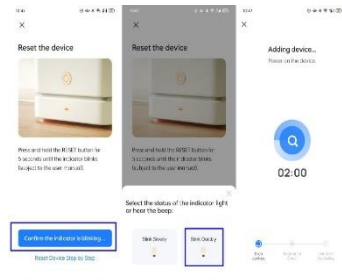

6. The thermostat will automatically appear on the screen.

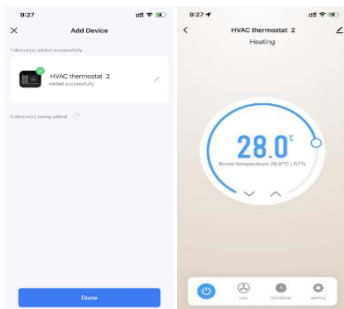

1. How the Home Screen Works

From outside and at home

1. When the user sets the thermostat to away mode, the thermostat will continue to protect itself from frost after setting the defrost temperature.

When the temperature is lower than the set defrost temperature, the heating will be turned on, meanwhile, the flame icon will be displayed on the thermostat.

2. If thermostat automatically enters the defrost mode when "away mode" is selected.

1. HOLD

The function has a relatively high priority, for example, whatever setting you make, when you switch the thermostat to float mode, all previously made pre-settings will be temporarily ignored, except for the float temperature, which will be maintained until the end of the set "hold period".

01 Press the "hold" button and enter the setting screen.

02 Press the first column of "hold temp", use the icon to set the desired hold temperature. (Temperature range 5 °C -35 °C).

03 Press the second/third column of hours/minutes, use the icon to set the desired "standby time".

04 Press the icon to save and return to the main display, or press "cancel" to delete the setting.

You'll see "hold left: **:**" on the screen. The time will count down to the set duration and then return to the normal program.

HISTORY

Shows the operating time (hours)/ambient temperature (°C)/ambient humidity (%) of the environment over the past 7 days.

01 Press the icon and enter Feature Settings .

02 Find the file "09. Energy Tariff", press it and access the setting screen.

03 Press Per Hour to set the Kwh value.

04 Press Per Kwh to set the value €.

05 Press the icon to save and return to the home screen.

06 Press the icon and enter the History Chart.

07 Three options are available: Run Time Graph, Temperature Graph, Humidity Graph

08 Press "Run Time Chart" to enter the screen. There are two texts on the top: Hours and Heat, you can click Hours to change the chart as below:

8.1 hours—Operating time, 8.2 KWh—energy consumer, 8.3 Cost—cost of energy

Please note: The cost is for reference only and is not used for specific payment vouchers.

Graphic Temperatures

01 Press "Temperature Graph" to enter the room temperature (°C) for the past 7 days

02 Press each date on that day's 24-hour chart

03 Press the icon to save and return to the history graph view.

Humidity chart

01 Press "Humidity Graph" to see the room humidity (%) over the past 7 days.

02 Press each date to display the room humidity for each hour on that day

03 Press the icon to save and return to the main display.

Holiday

The thermostat will maintain this temperature for the duration of your holiday and then automatically return to programme mode when you return.

01 Press Holiday and then Holiday Temp to select the holiday temperature.

02 Press the icon to enable this feature in the upper right corner.

03 Press the years/month/day column on "Holiday Start" and "Holiday End" to select the desired date.

04 Press the icon to save and return to the main display. Displayed "Holiday until **/** **:**"

Humidity and temperature

Press the icon to check the humidity and temperature



Programma / Schedule

01 Press the icon and enter the function settings.

02 Find the "Schedule" option, press it, and there are four options:

Weekdays /Weekends Weekday/Weekend, 7 days, 24 hours, None.

03 For example, select the programming mode to 7Days.

04 Press the icon to save and return to the main display.

05 Press "Schedule" on the main display and enter the "edit" screen.

06 You can select Monday to Sunday for editing.

swon ON OFF swoff

swon ON (ad esempio in modalità riscaldamento).

--Press each column of Hour, Minute and use the Up and Down buttons to set the desired value. For example: the set time is 06 (hour): 30 (minute).

--Press the third "temperature" column to set the desired temperature.

For example: the set temperature is 23°C

--Repeat the above steps to set:

Day: 08 (hours): 30 (minutes), 18C

Evening: 18 (hours):00 (minutes), 23C

Night: 23 (hours):00 (minutes), 20C

Four periods are:

06:30-08:30: During this time the temperature will remain at 23°C.



08:30-18:00: During this time the temperature will remain at 18°C.

18:00-23:00: During this time the temperature will remain at 23°C.





23:00-06:30: during this period the temperature will remain around 20°C.

Configuration Settings Press the icon on the home screen and enter the setup menu <i>Date & time</i> Data & ora	01) Time zone selection 02) Time setting 03) Daylight Saving Time (DST)
Backlight Retroilluminazione	Ambient light dimming
Standby Screen Schermata di standby	Standby screen 01) Duration: 3min, 10min, night only 02) Type: Clock, Default, Offscreen
Screen lock Blocco schermo	4 digits pin, if you forget the password the Admin Password is 8657
Network settings Impostazione di rete	01) WiFi Setup 02) QR Code 03) Mac Address
Feature settings Impostazioni delle funzioni	01) Temperature Format 02) Temperature limit 03) Change Differential 04) Exit Delay 05) Absence Temperature 06) Defrost: Enable/Disable 07) Sensor Selection: Integrated sensor / Remote air sensor / Floor sensor only / Floor sensor and integrated / Remote air and floor sensor 08) Humidity Sensor Calibration 09) Energy tariff Set power consumption per hour Set the unit cost per Kw/h 10) Open Window Function Disable/enable this feature 11) Floor Temperature Limit Range from 20°C to 60°C 12) Working Mode Selection: Heating mode/Timer mode
Schedule Programma	Weekday/weekend 7 days – 7 days 24 hours – 24 ore None – Nessuno
Hold temperature Mantiene la temperature	Maintains temperature 5-35C Mantiene l'orario 0~23hrs, 0~59 minutes
System information Info del Sistema	Version number, QR code



Setting the Clock

- 01 Press the icon , then press "Clock & Date & Time", press "Clock Setting".
- 02 Press the Day/Month/Year, Hour/Minute column, use the icon  to set the desired value.
- 03 Press the icon  to save and return to the main display.



Screen brightness

- 01 Press the icon  and press "Backlight" to enter the backlight setting.
- swon  significa che la luminosità cambia automaticamente.
 swoff  significa che la luminosità cambia manualmente.
- 04 Use the icon  to adjust the desired brightness.
 - 05 Press the icon  to save and return to the main display.

1. Screen saver

- 01 Press the icon  and press "Standby Screen" to enter the setting screen.
- 02 3min, 10min and Night Only options are available.
- 03 For example, set the standby time to 10 minutes.
- 04 Press the icon  to save and return to the main display

Screen lock

- 01 Press the  icon and "Lock Screen" to enter the setting screen.
- swon 
- 02 For example, the lock pin setting is 5209.
Press each column to send the 4 digits to 5209.

03 Press the icon  to save and return to the main display.

Note: If you forget your password, your primary PIN is 8657.

Network Settings

01 Press the  icon and "Network Settings" to enter the setting screen.

02 You can select a WiFi network and set the WiFi password on the 01- Wi-Fi Configuration screen.

04 Exit Delay: To avoid fast switching, you can enter an output delay. (Default value is 00, means no delay) This

If your thermostat model has RS485 functionality, you can set the Modbus address by pressing 05-Modbus Address.

Feature settings

01 Temperature Format: Set Select between °C and °F.

02 Temperature Limit: Sets the limiting range of the temperature setting.

03 Press "Switch Diff" to enter the setting interface.

There are four options: 0.5, 1, 2, 3

Select the desired number and press the icon  to save and exit.

If setpoint=20°C, switching differential value=0.5. In heating mode: The thermostat provides a heating power of 19.5 °C and switches off at 20.0 °C.

04 Exit Delay: To avoid fast switching, you can enter an output delay. It can be set from 0 to 15 minutes. (Default value is 00, means no delay) This feature helps prevent "short cycles" of the system.

05 Absence temperature: sets the Absence temperature.

06 Defrost: Enable/Disable:

The thermostat will automatically enter the defrost mode when the room temperature drops below the defrost temperature.

07 Sensor Selection:

There are five options: press it to enter the calibration screen.

Built-in sensor (default): Press this to enter the calibration screen.

Remote Air Sensor(NTC10Kohm): Press this to enter the calibration screen.

Floor sensor only(NTC10Kohm): Press it to enter the calibration screen.

Built-in floor sensor.

Remote air and floor sensor (NTC10Kohm).

08 Humidity sensor: Calibrate the humidity.

09 Energy tariff.

Set the power consumption, KW/h and €/KW, so the user can check the energy or cost in the history chart on the home screen.

10 Open window function.

The thermostat can detect the open window by measuring the rapid drop in temperature. The thermostat will turn off the heat for 30 minutes if an open window is detected.

11 Floor Temperature Limit: Sets the floor sensor limit.

12 Selecting the working mode: thermostat and chronothermostat mode.

1. Maintain temperature



Same as the Hold function on the home screen.

System Information

Press the icon  and "system information" to check the version number.

Reset to factory settings

Warning: Resetting will cause all current settings to be lost and return to factory default settings.

01 Press the icon  and then press " " to enter the setting interface.

02 Press "Reset" to factory settings and press  to exit.

Modalità 2- Modalità timer

The timer mode is used to program the voltage-free contact.

Enter  and press Feature Settings, select the timer mode.

Follow the steps below to program the timer.

01 Press "programming" on the home screen.

02 Press the day of the week and enter the setting screen.

You can select the periods to be scheduled, for example, "Morning, Day, Evening, Night", each period has options 

03 Each period has the start time on and the end time on Off, select the desired time for each period.

04 Press "Copy to" to select other days.

05 We can also make the weekend setting by following the same steps above.

Enhanced Mode

The boost function allows you to override the thermostat to not follow the programmed settings and manually turn it on for the desired period of time. This feature overwrites the preset time settings for a desired amount of time. This can be turning over-ride on or off. To activate the boost, follow these steps.

01 Press the "boost" icon.

02 Select the desired "boost" mode NO or OFF

icon size  to set the desired hours.

icon size  to set the desired minutes.

icon to return  per salvare e tornare alla schermata principale

06 The remaining "boost" time will be displayed at the top of the screen.

07 To cancel the "boost", press the main "boost" icon and press Cancel

Install the thermostat visually.

Please read the instructions to better understand our products.

Do not install in areas near heat sources that would affect its operation.

This flush-mounted thermostat requires a 35mm power box in the wall / Three DIN modules

Step 1

Using a flat-blade screwdriver, loosen the screw from the bottom of the thermostat and remove the front from the backplate.

Step 2

Store the thermostat front panel in a safe place.

Follow the wiring diagram to connect the terminals.

Step 3

Screw the back plate of the thermostat into the wall mount box.

Step 4

Place the front panel of the thermostat on the back-plane and tighten the screws.

Dimensions

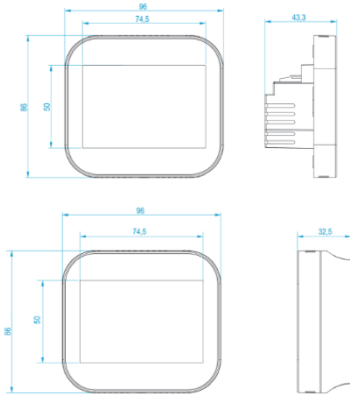

Technical specification

Power supply: 85-230Vac, 50/60Hz

Setting temperature range: 5-35 °C

Temperature accuracy: ± 1 °C

Power Consumption: 1W

Floor temperature limit: 20-45 °C

Maximum switching current: 3A/16A (optional)

LCD screen size: 3.5 inch

Touch: Capacitive Touch

Size: 96*86*42.5(W*H*D)mm

Degree of protection: IP40

Optional sensors for measuring room and or floor temperature NTC10Kohm @25°C

Wiring diagram

